

MODIFIED 02:22:29 PM 06/14/2002			
UNLESS OTHERWISE SPECIFIED		ORIGINATOR	
FRACTIONS	DECIMALS	ANGLES	DRAWN
			CHECKED
1. BREAK ALL SHARP EDGES 1/64 MAX.		APPROVED	
2. DO NOT SCALE DWG.		USED ON	
3. DIMENSIONING IN ACCORD WITH ANSI Y14.5 STD'S.		MATERIAL	
✓ MAX. ALL MACHINED SURFACES			
 <b>Fermi National Accelerator Laboratory</b> United States Department of Energy			
D:\ANGIE.WORK\ccm_proto1_v2\ccm_proto1_v2.prj			
SIZE	SCALE	FILMED	DRAWING NUMBER
D	1:1		PAGE 01 of 02
			REV A

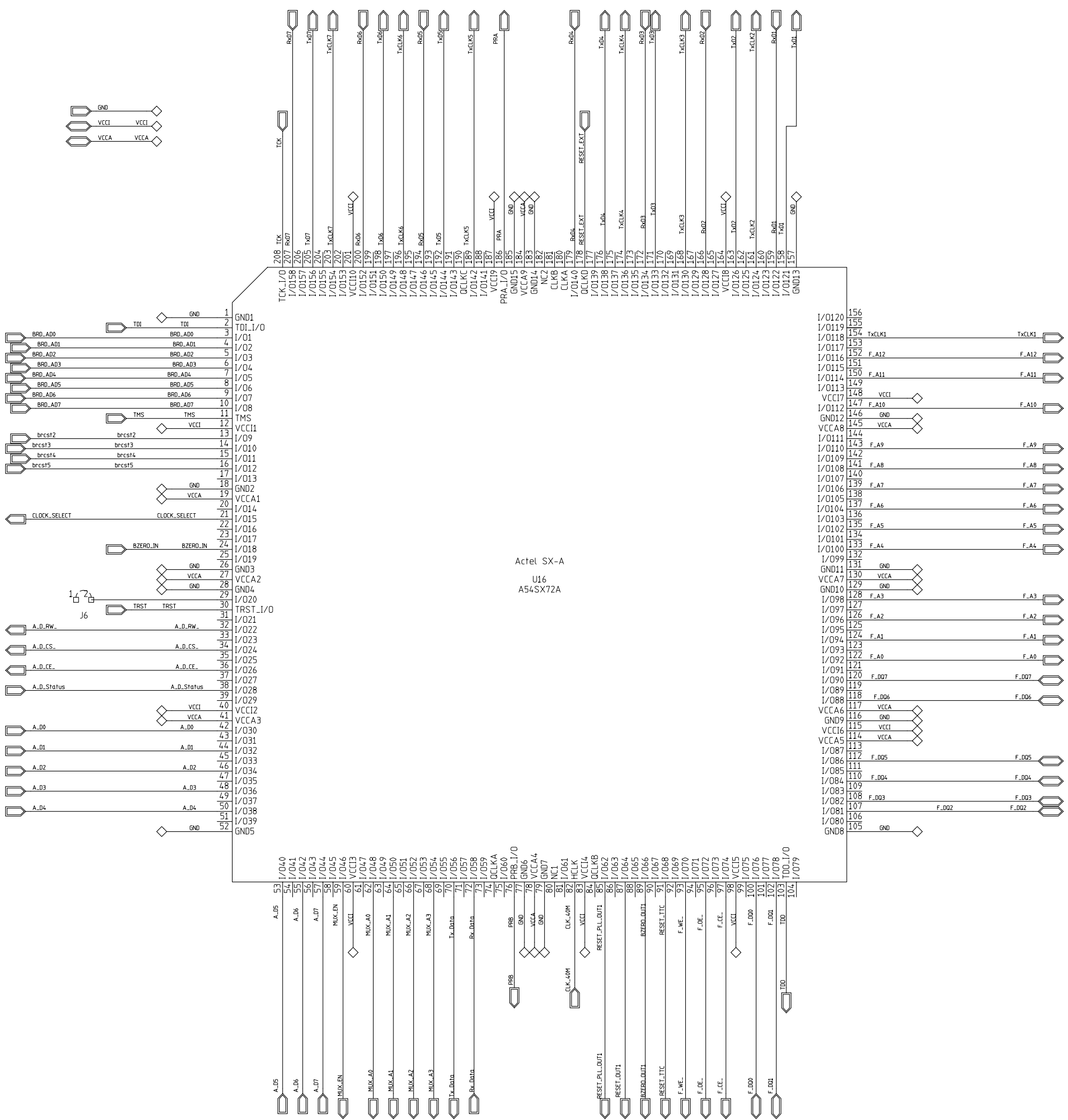

REVISIONS			
REV	DESCRIPTION	DATE	APPROVED

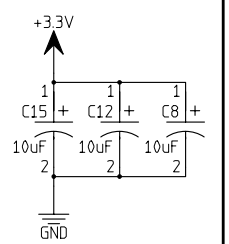
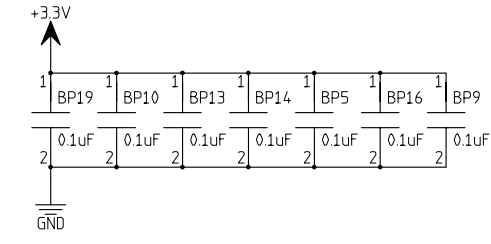
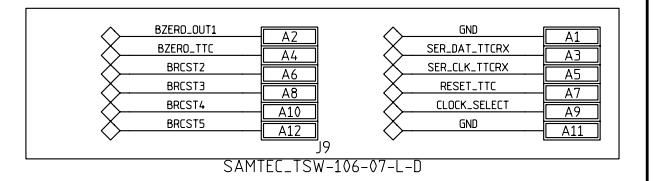
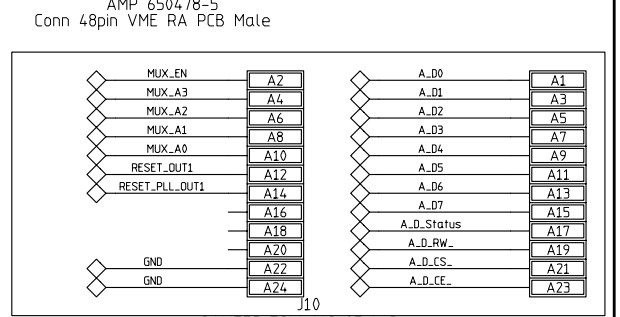
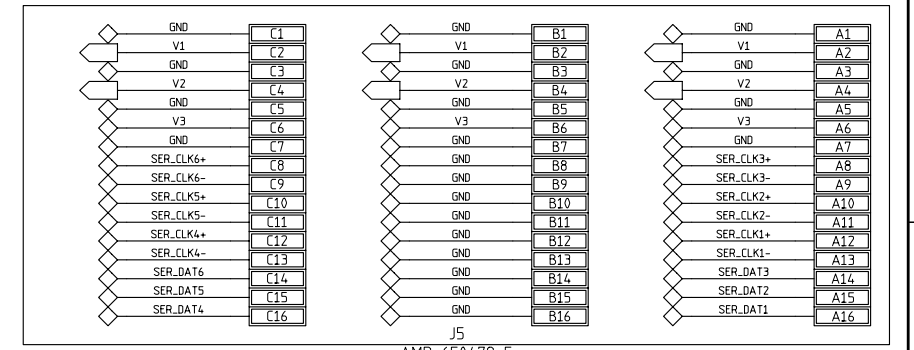
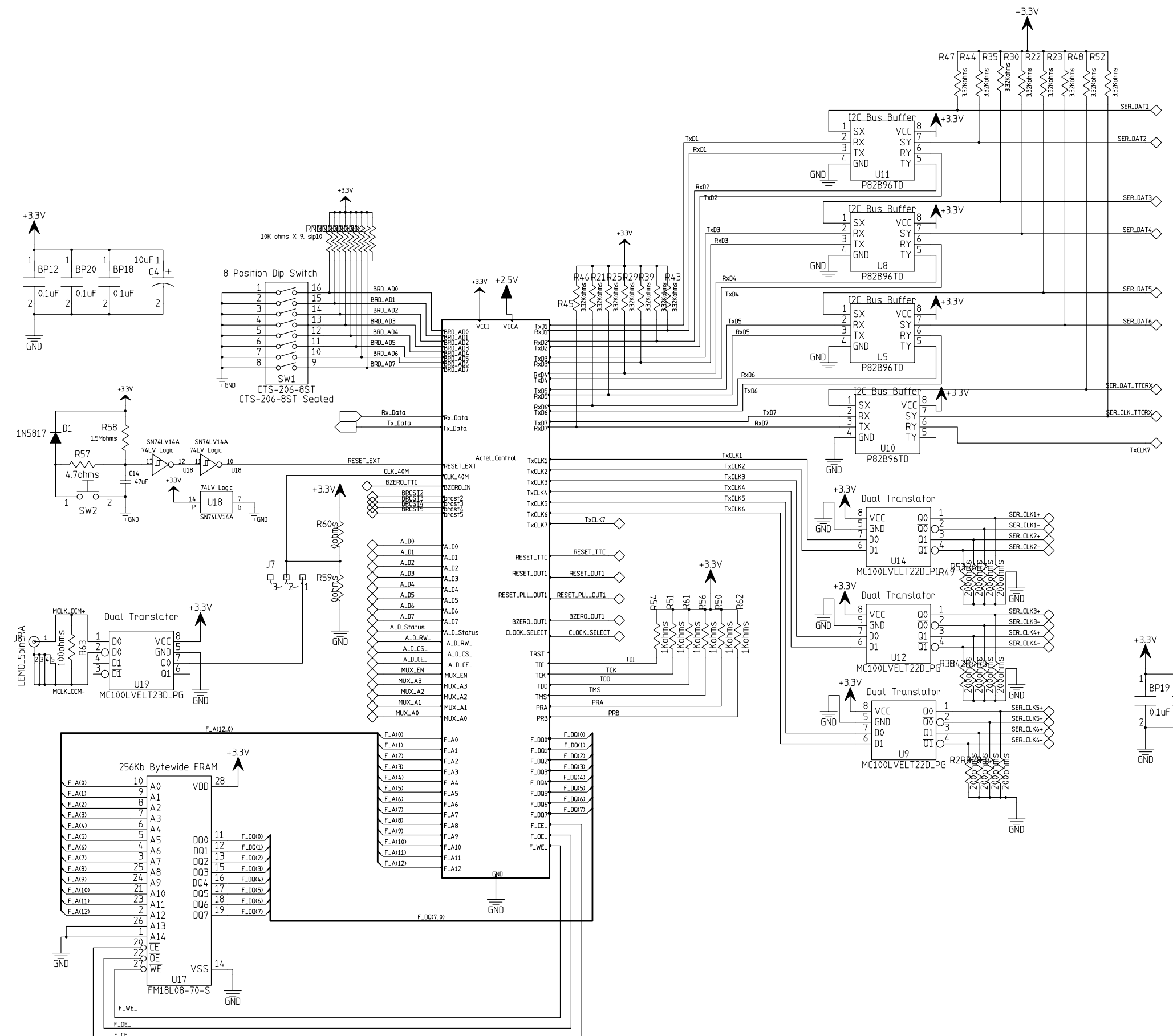

CONTRACT NO.			
APPROVALS	DATE		
DRAWN			
CHECKED			
ISSUED		SIZE	FSCM NO.
MODIFIED		DWG. NO.	REV
02:26:23 PM 06/14/2002			A
PAGE 02 of 02		HierPage 01HierPage 01HierPage 01	